

preliminary

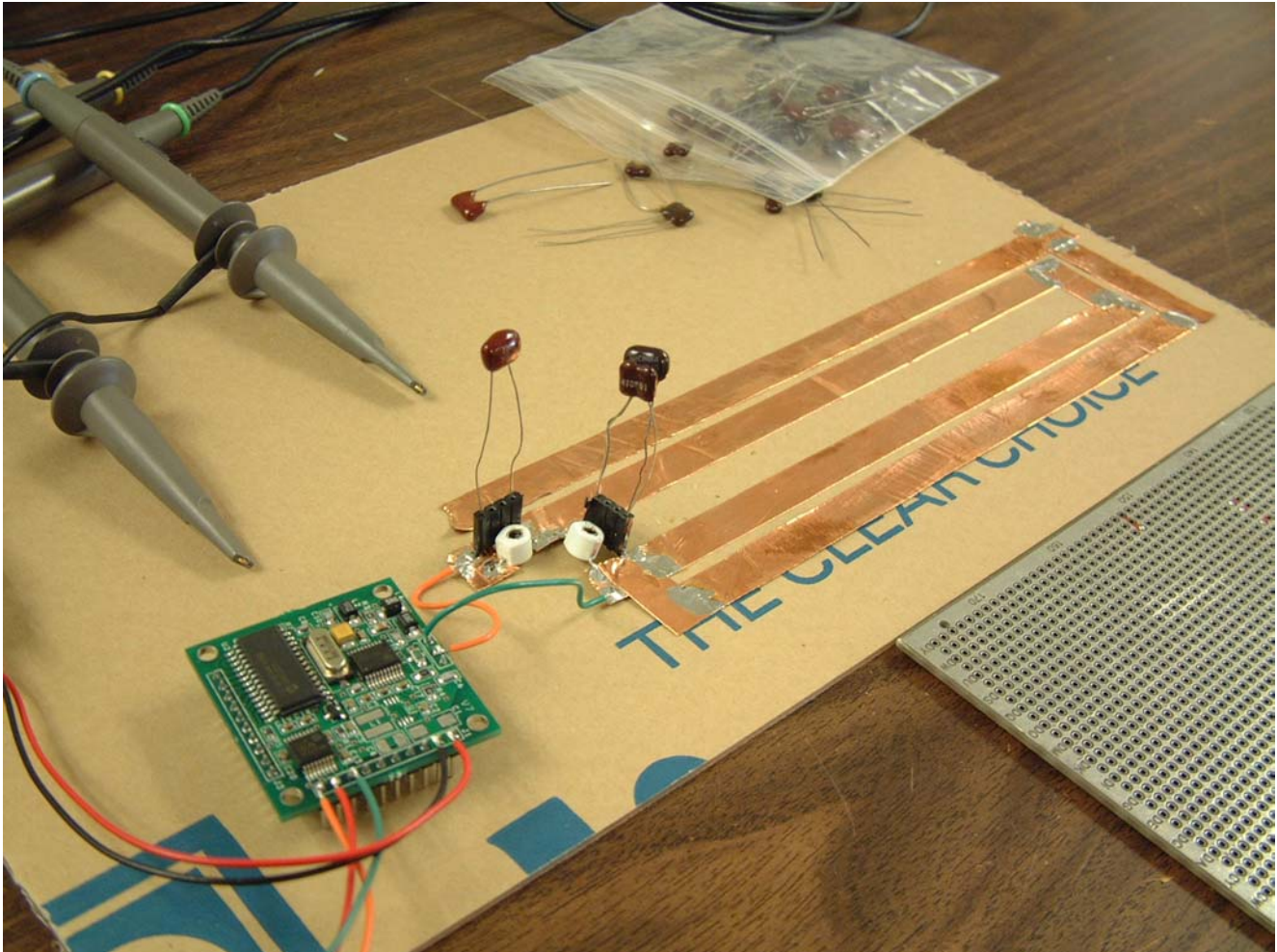

Antenna Design Guide for the SkyeRead M1



Background

The SkyeRead M1 is designed for low power RFID applications that require less than 4 inches read range when using the internal antenna of the M1. Alternatively, the M1 can directly drive an external antenna to provide up to 10 inches read range. And for applications that require more than 10 inches read range a power amplifier can be used to drive an external antenna.

The SkyeRead M1 comes with an integrated internal antenna. And The M1 also works with standard external antenna modules like the SkyeRead EA1. But many customers need to design custom external antennas to best fit their specific application requirements.

SkyeTek and its partners can also provide custom RFID antenna design services

preliminary



Introduction

This antenna design guide provides some basic theory as well as several practical examples of how to design high performance cost effective RFID antennas for use with the SkyeRead M1 RFID reader module.

All antenna connections are made at the Antenna Connector J2.

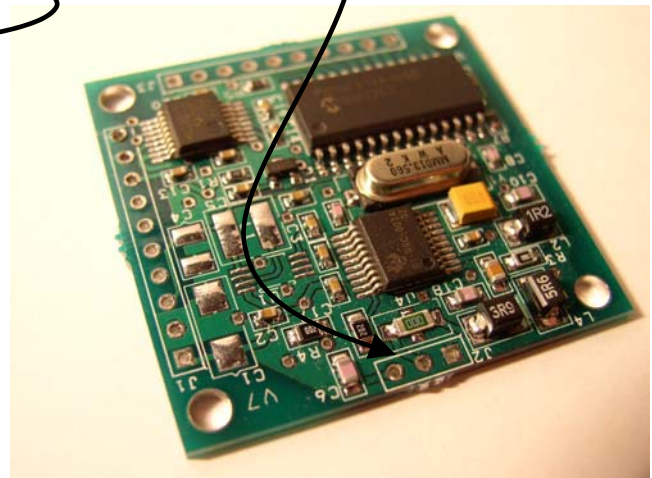
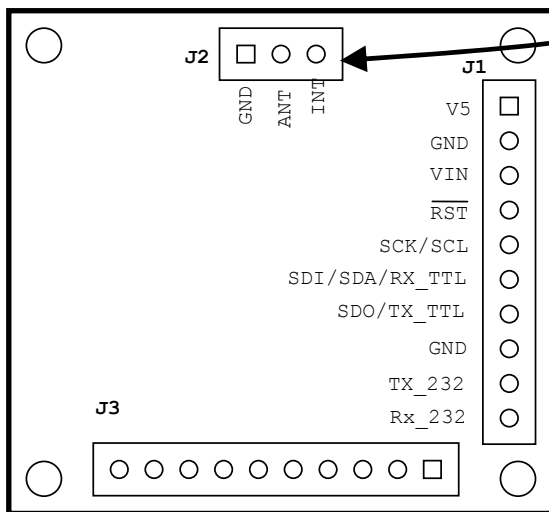

J2 Pin Descriptions

J2		
Pin	Name	Description
1	GND	Antenna Ground.
2	ANT	Antenna Output pin. ANT provides 50 ohms output for matching an external antenna. Jumper ANT to INT to enable the on-board antenna.
3	INT	Internal Antenna pin. Jumper INT to ANT to enable the on-board antenna. Remove the jumper between INT and ANT to disable the on-board antenna and connect an external antenna.

preliminary



Using an oscilloscope the typical waveform at ANT of the M1 can be observed. It should look like a 13.56MHz sine wave, approximately 10Vpp. Note that depending on the firmware version in the M1, the antenna drive signal at the ANT pin of J2 is typically a host should first send a tag command to the M1 in which the RF_F is set (see SkyeTek protocol for more details on RF_F).

Internal Antenna

The internal antenna of the SkyeRead M1 provides 70mm read range and 100mm x 100mm read coverage. Connect ANT to INT to enable the internal antenna.

External Antenna

Here is the SkyeRead EA1 external antenna.

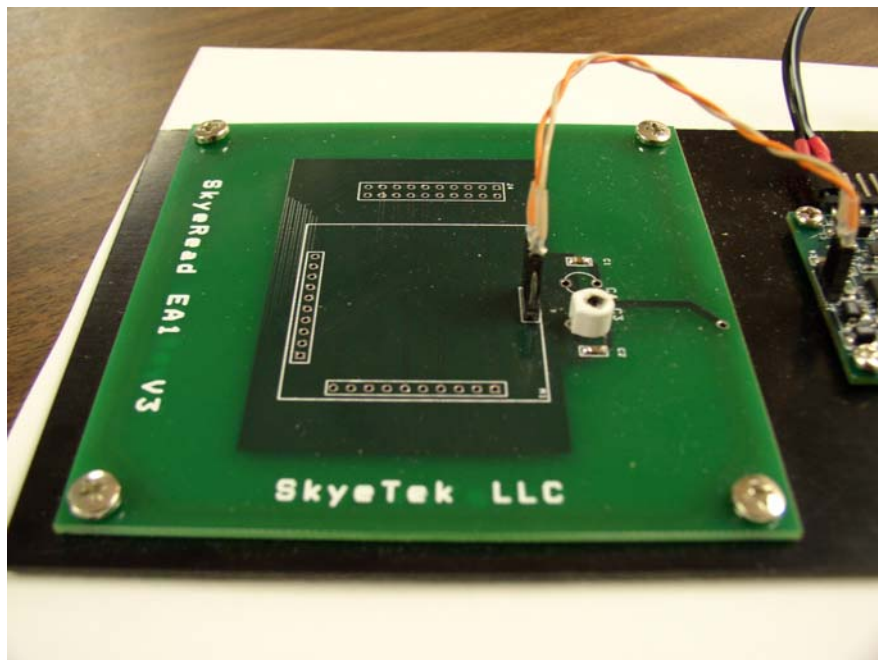

Here is the circuit of the SkyeRead EA1.

preliminary

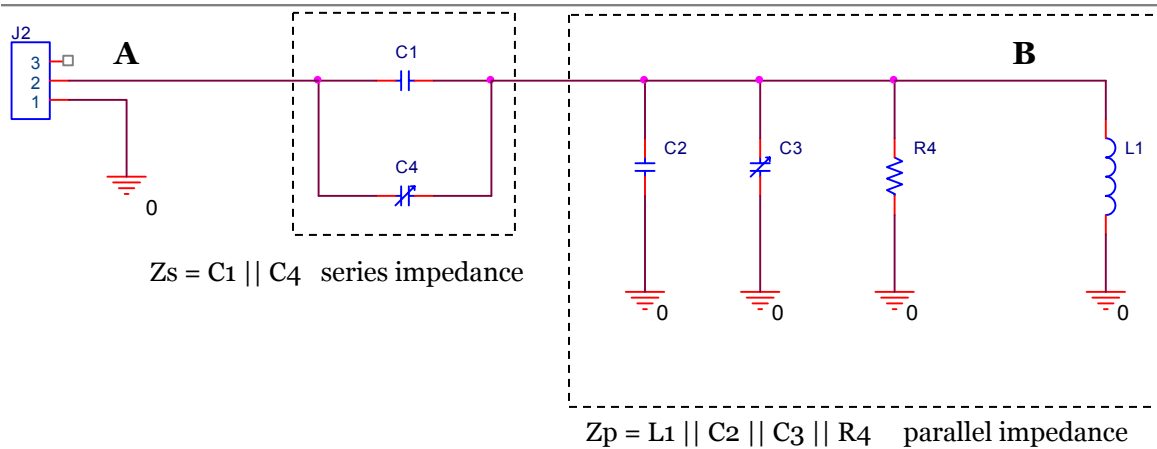

Inductor L1 is the physical antenna loop.

Z_p forms a resonant circuit tuned at 13.56MHz and so there is an amplification of the ANT signal at B. You can measure and compare the amplitudes of the sine waves at points A and B as you first adjust C3 to get a max amplitude on the signal at B, and then adjust C4 to further maximize the amplitude of the signal at B.

Custom Antennas

The Antenna Must be a Loop

Inductive loop RFID antennas can be made from any electrically conductive material such as tape, wire or tubing. The basic requirement is that the antenna is a “loop” with one or more turns. As a general rule circular and square antenna loops are optimal geometries. The length to width ratio of a rectangular antenna should not exceed about 3:1. You can design a custom antenna to provide more read range and more read coverage that you can get from the internal antenna of the M1.

L1 is the RFID loop antenna. The antenna can be made from wire, copper tape, copper tubing or other conductive materials.

ANT has a typical output impedance of 50-ohm at 13.56MHz. The external antenna should be matched to this 50-ohm output drive impedance. The series capacitance Z_s provides the matching adjustment.

Design Procedure

The following antenna design procedure can be used. Start with a measured or calculated inductance for L1, then calculate the capacitor values, then measure and adjust for optimal performance.

preliminary



1. Determine the inductance of L1.
 - a. Build and measure the inductance of L1.
 - b. Design and calculate the inductance of L1.
2. Determine the capacitance Cp. Pick appropriate values for C2 and C3
3. Determine the capacitance Cs for matching the M1 output impedance to the antenna input impedance. Pick appropriate values for C1 and C4.

The resonant frequency of the parallel impedance Zp circuit is governed by the following equation

$$2\Pi f = \frac{1}{\sqrt{L1 \cdot Cp}}$$

where,

L1 is the inductance of the antenna loop

R4 is ignored

Cp = C2 || C3

f = 13.56MHz is the desired resonant frequency.

Example 1

Here are the component values of the SkyeRead EA1 external antenna:

C1 = 22pF 0805 ceramic chip capacitor DigiKey p/n PCC220CNCT-ND

C4= 3 to 10pF variable capacitor DigiKey p/n SG1015-ND

C2 = 100pF 0805 ceramic chip capacitor DigiKey p/n PCC101CGCT-ND

C3 = not present

R4 is not present

L1 = 1.05uH is the loop inductance of the 2-turn PCB antenna trace approximately 95mm x 95mm.

preliminary



Example 2 – The internal antenna of the M1

For the internal antenna of the M1 the component values are as follows:

C1 = 0 ohm resistor

C4 = ---

C2 = 1000pF 0805 NPO ceramic chip capacitor DigiKey p/n PCC101CGCT-ND

C3 = ---

R4 = ---

L1 = 150nH is the loop inductance of the single-turn PCB antenna trace

preliminary



Example 3 – copper tape external antenna

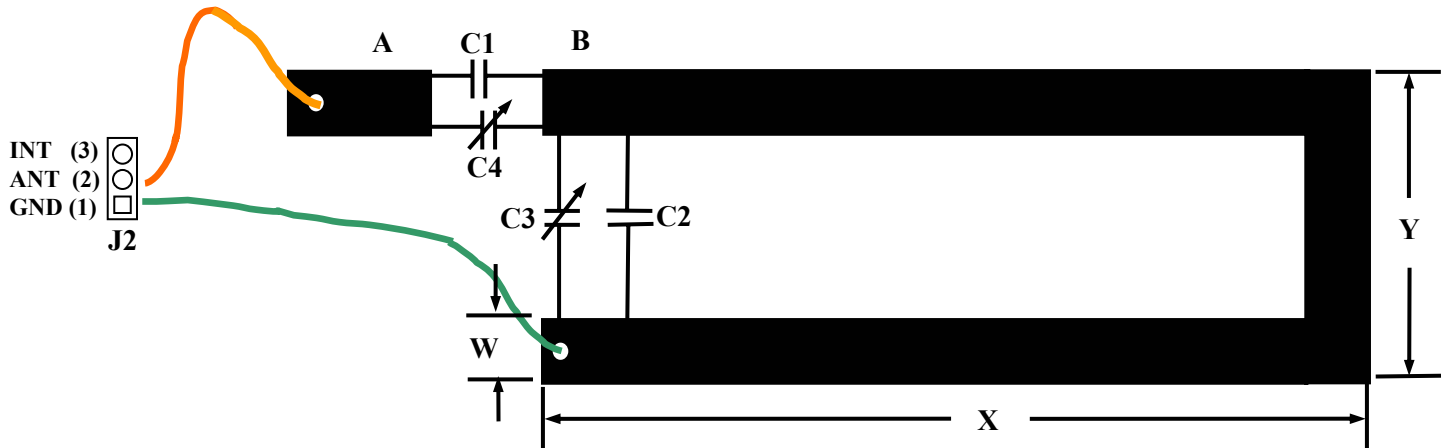

L1 is 1-turn rectangle loop copper tape

X=170mm

Y = 30mm

W = 10mm

C1 = 47pF dipped mica capacitor

C4 = ---

C2 = 800pF dipped mica capacitor (470||330)

C3 = ---

R4 = ---

While monitoring A and B with an oscilloscope you will see how this antenna is susceptible to detuning from mounting on metal and even from the presence of one or more tags. In order to design the antenna so that you could mount it onto either metal or non-metal and see similar performance, the antenna can be designed with a ground ring or a shield on a top and bottom layer. The next example shows a ground ring around the antenna. See the following drawing and picture.

preliminary



Improved antenna with ground shield.

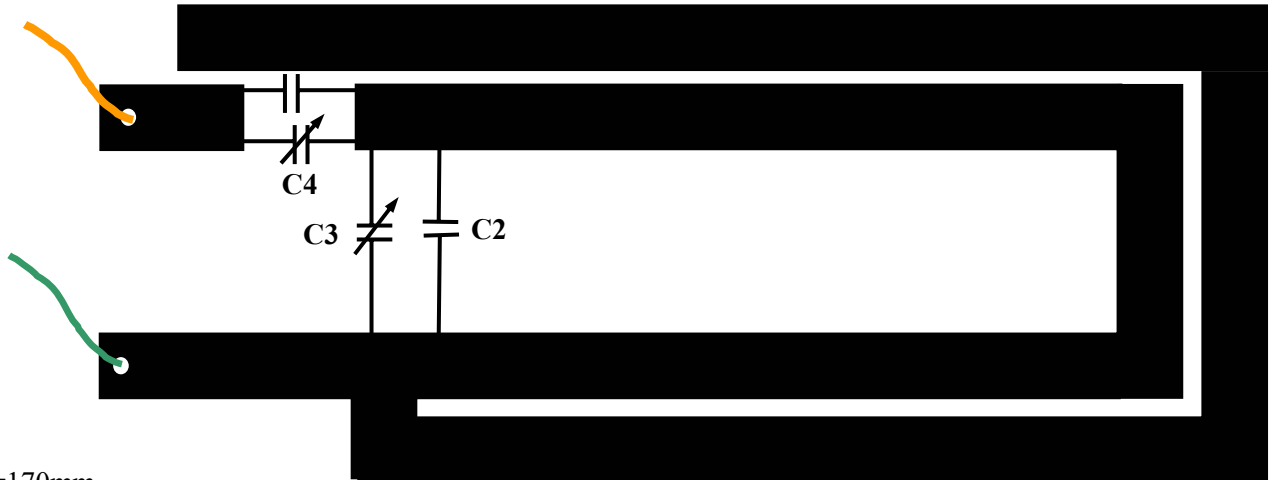

X = 170mm

Y = 30mm

W = 10mm

C1 = 220pF dipped mica capacitor

C4 = ---

C2 = 1810pF dipped mica capacitor (470||560||560||220)

C3 = ---

R4 is not present

preliminary



The following pictures are examples of how to build a prototype antenna. If you will mount the antenna on metal then you should design the antenna on metal such as shown here.

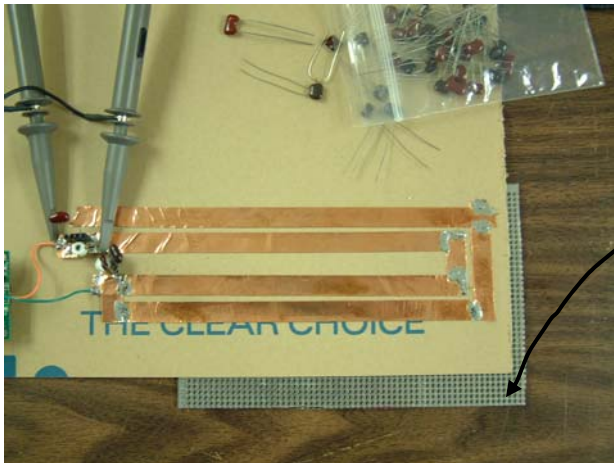

Design the Antenna already on metal

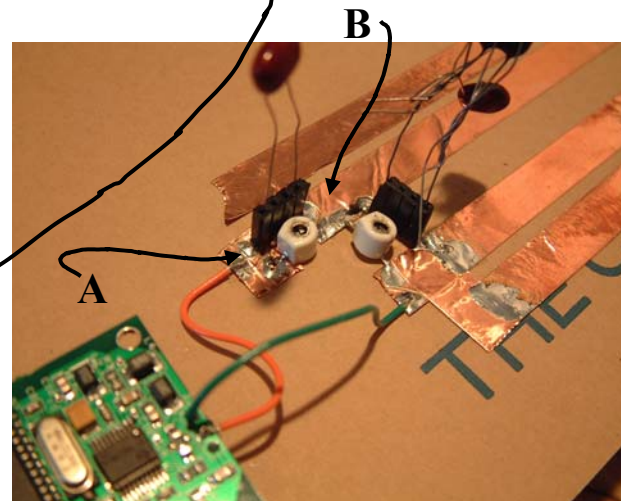

Points A and B shown